

Sidekiq™ VPX410

Multichannel RF Tuner. Covering 1 MHz – 18 GHz in a CMOSS/SOSA–Aligned 3U VPX Card







ACCESS MORE RF SPECTRUM IN A SINGLE 3U VPX SLOT

MULTICHANNEL RF REACHES UP TO 18 GHZ FOR RAPID SITUATIONAL AWARENESS

Sidekiq VPX410 is a revolutionary, CMOSS/SOSA – aligned software-defined radio (SDR) multichannel RF tuner solution enabling SIGINT/EW/ Communications use cases in a 3U VPX form factor. Combining four RF receive tuners plus one RF transmit tuner in a single 3U VPX card, Sidekiq VPX410 enables access to RF spectrum between 1MHz and 18 GHz with up to 1 GHz of instantaneous bandwidth per channel. Both phase coherent and independent tuning modes are available to enable a range of operational use cases, including fast spectral scanning, direction finding, rapid frequency hopping and electronic attack. Sidekiq VPX410 is interoperable with Sidekiq VPX400 and other 3U VPX digitizers and SDRs.

*Bypass path for operation below 6GHz includes amplifiers + pre-select filters; sub 400MHz is supported with pass through mode.

KEY HIGHLIGHTS

-  3U VPX Form Factor with VITA 67,3 RF Access, SOSA Profile 14.6.11
-  RF Tuner Providing Access from 1M MHz to 18 GHz
-  Four RF Receive Tuners and One RF Rransmit Tuner
-  1 GHz Instantaneous Bandwidth per Tuner Channel
-  Supports Frequency-Phase Coherent and Independent Operation on All RF Channels
-  Low Power Operation Approximately 20 Watt Total with All Tuners Operational at Full Bandwidth
-  Optional Single Card 3U VPX Chassis for Development, Lab Use, and Light Field Testing

BLOCK DIAGRAM

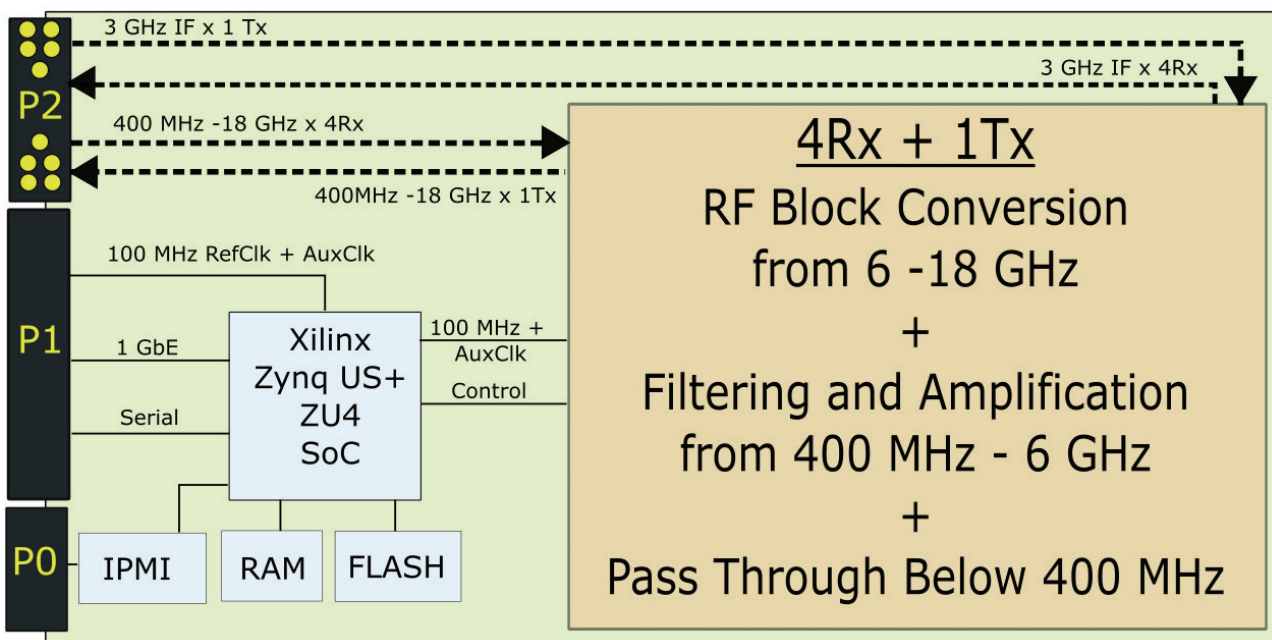

GENERAL SPECIFICATIONS

- Compatible to ECC3 environmental specification
Conformal coating available

SOSA PROFILE SPECIFICATION

- SOSA profile 14.6.11-4 with VITA 67.3C 14 SMPM compatible P2 block;
aligned to SOSA v1.0e

PHYSICAL SPECIFICATIONS

FORM FACTOR

- 3U VPX

DIMENSIONS

- 160 mm x 100 mm x 25 mm

PITCH

- 1 inch

THERMAL MANAGEMENT

- Conduction cooled

TYPICAL POWER CONSUMPTION

- ~ 20 Watt (assumes all four RF receive tuners and one RF transmit tuner are active)

OPERATING TEMPERATURE RANGE

- -40° C to +70° C

DIGITAL SPECIFICATIONS

CONTROLLER PROCESSOR

- AMD® Zynq® Ultrascale+ MPSoC ZU4 2 GB of DDR4 RAM, 8 GB of non-volatile flash Linux operating system

IPMI COMPLIANCE

- Version 1.5

CONTROL INTERFACE

- 1 GbE via P1 on the control plane

RF RECEIVE TUNER SPECIFICATION

NUMBER OF TUNERS

- 4

RF COVERAGE

- 1M MHz to 18 GHz

IF FREQUENCY

- 3 GHz

INSTANTANEOUS BANDWIDTH (PER TUNER)

- 1 GHz

SPURIOUS FREE DYNAMIC RANGE

- > 70 dB

GAIN CONTROL

- 0-20 dB in 1 dB steps

NOISE FIGURE

- < 12 dB

IIP3

- > +5 dBm

TUNER OPERATING MODES

- Phase Coherent or Independently Tunable

RF RECEIVE TUNER RF ACCESS PORTS VIA VITA 67.3 ON P2

- Four RF input ports from 400 MHz - 18 GHz (Pass through mode for sub 400MHz operation)
- Four IF output ports at 3 GHz (Sub 6 GHz operates as an RF output)

RF TRANSMIT TUNER SPECIFICATIONS

NUMBER OF TUNERS

- 1

RF TUNING RANGE

- 1M MHz to 18 GHz

IF FREQUENCY

- 3 GHz

INSTANTANEOUS BANDWIDTH (PER TUNER)

- 1 GHz

TUNING STEP SIZE

- 25 MHz

SPURIOUS FREE DYNAMIC RANGE

- > 70 dB

RF TX POWER OUTPUT

- +5 dBm

TX OIP3

- > +20 dBm

RF TRANSMIT TUNER RF ACCESS PORTS VIA VITA 67.3 ON P2

- One RF output port from 400 MHz - 18 GHz (Pass through mode for sub 400MHz operation)
- One IF input port at 3 GHz (Sub 6 GHz operates as an RF input)

Specifications subject to change without notice.

Epiq Solutions is a business dedicated to advancing RF technology through products designed and manufactured in the U.S.A.

Epiq Solutions exports its products strictly in accordance with all US Export Control laws and regulations which shall apply to any purchase or order.

