



Sidekiq™ NV800







Eight-Channel, Phase Coherent, RF Receiver Supporting VITA49 Data Streaming and WhiteRabbit® Synchronization

A HIGH PERFORMANCE, FAST HOPPING, MULTI-CHANNEL SDR FOR LOW POWER RF SPECTRUM AWARENESS

COMPLETE SOFTWARE-DEFINED RADIO PLATFORM FOR SPECTRUM MONITORING, WIRELESS DETECTION, SIGINT, C5ISR, AND COUNTER UAS AND OTHER MISSION CRITICAL APPLICATIONS

The NV800 is a high performance eight receive, one transmit SDR platform that enables rapid deployment for RF awareness applications. Capable of operating in either phase coherent or independent modes, the NV800 supports fixed frequency and fast frequency hopping modes of operation, both of which can support direction finding use cases. Fast frequency hopping on each channel can support total spectrum coverage of almost 500GHz-per-second. The NV800 is easy to install, only requiring a 1GbE connection for POE++ and command & control (DC power input is also an option), and a 10GbE for high speed data streaming using VITA49.

KEY HIGHLIGHTS

-  Standalone SDR Platform with Eight RF Receivers and One RF Transmitter
-  Wide RF Tuning Range, Up To 6 GHz on All RF Channels with Future Extension to 18GHz on One RF Receiver Channel
-  Up to 50MHz Instantaneous Bandwidth on All RF Channels
-  Supports Frequency-Phase Coherent and Frequency-Phase Independent Operation Across All Eight Receivers
-  Fast Frequency Hopping Supported on All RF Channels
-  Typical Power Consumption Under 25W; POE++ or DC Input
-  Support for WhiteRabbit Synchronization of < 1ns

BLOCK DIAGRAM

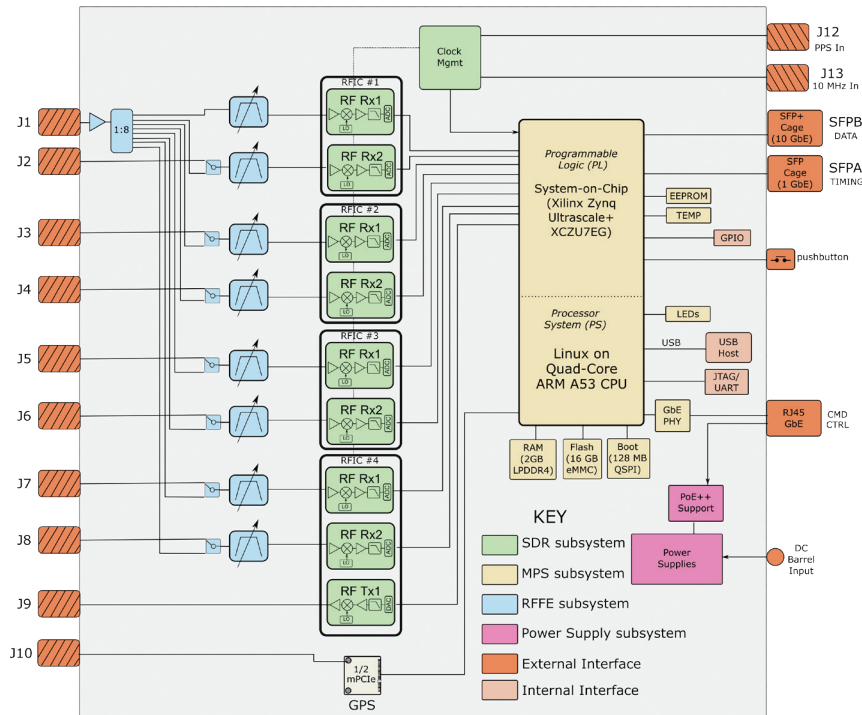

GENERAL SPECIFICATIONS

ENVIRONMENTAL OPTIONS

- Storage -40° to 85° C
- Operation, -40° to 70° C

PHYSICAL SPECIFICATIONS

DIMENSIONS

- 9.92" x 7.24" x 2.0" (25.2cm x 18.4cm x 5.1cm)

WEIGHT

- 3.68 lbs

DIGITAL SPECIFICATIONS

FPGA

- AMD® UltraScale™ XCZUEG FPGA

SYNCHRONIZATION

- WhiteRabbit IEEE 1588-2019

RF TRANSMITTER SPECIFICATIONS

NUMBER OF TRANSMITTERS

- One

RF TUNING RANGE

- 30 MHz to 6 GHz

RF TUNING STEP SIZE

- < 5 Hz

RF LO TUNING TIME

- < 70us

RF CHANNEL BANDWIDTH

- Up to 50 MHz

TYPICAL RF OUTPUT POWER

- Up to +0 dBm

D/A NUMBER OF BITS

- 16

RF RECEIVER SPECIFICATIONS

NUMBER OF RECEIVERS

- Eight

RF TUNING RANGE

- 30 MHz to 6 GHz

RF TUNING STEP SIZE

- < 5 Hz

RF LO TUNING TIME

- < 70us

RF CHANNEL BANDWIDTH

- Up to 50 MHz

TYPICAL RX NOISE FIGURE

- 7 dB

TYPICAL RX IIP3

- +5dbm

A/D NUMBER OF BITS

- 16

Specifications subject to change without notice.

Epiq Solutions is a business dedicated to advancing RF technology through products designed and manufactured in the U.S.A.

Epiq Solutions exports its products strictly in accordance with all US Export Control laws and regulations which shall apply to any purchase or order.

